

Soho SlimLine

Intro

Soho Slimline cabinets provides an aesthetic, functional, decorative and economic solution for cabling installations.

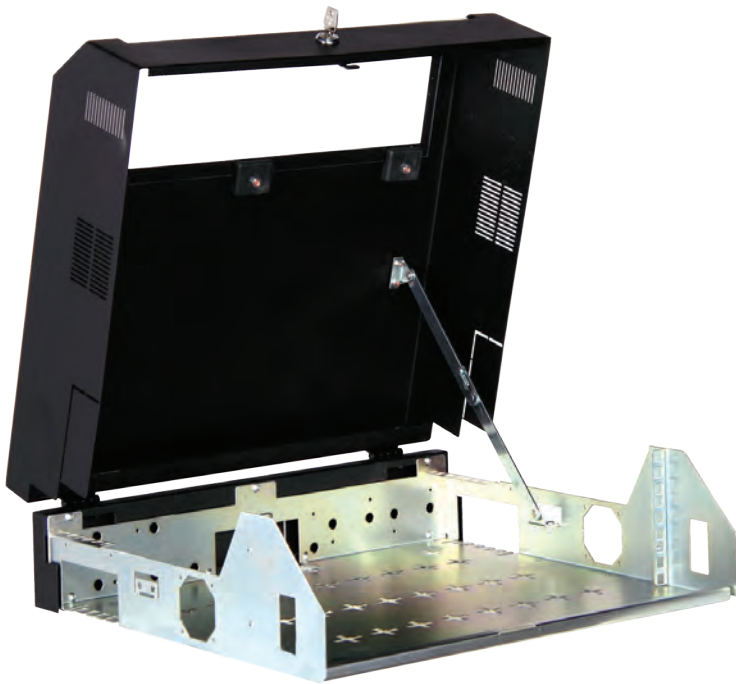

GENERAL CHARACTERISTICS

- Width is 500 mm
- Depth is 470 mm
- Height is 140 mm (Vertical)
- Easy to access
- Completely opening front door
- Plexi-glass front window in front door
- Lockable front door
- Mechanical distance holder
- Large cable openings for multi-cable entry
- Breakable fan holes
- Fast installation, low manpower
- Time saving installation
- Heavy duty base plate
- 19" 5U device mounting capacity (2 vertical + 3 horizontal)
- 80 kg. load carrying capacity (for wall mounted installation)



Sturdy and Sleek Design

Soho Slimline rack cabinets provide a professional use thanks to the thin and functional structure.

GENERAL CHARACTERISTICS

- Heavy duty hinges
- Slim depth only 140 mm
- The front cover open with a mechanical stop and locked with "O" type lock unit
- Sturdy and strong steel construction
- Thanks to its functional structure for up to 24 users, network distribution is made easy
- Punched holes for device fixing or cable management
- The bottom chassis have a monobloc twisted and welded structure
- Surface finish: Durable electrostatic powder coating against impact, scratches and dust
- Color: RAL 9005 black and RAL 7035 light grey
- High Quality Package: Shrink plastic wrapped with on high density cardboard. Styrofoam supported corners



Soho SlimLine

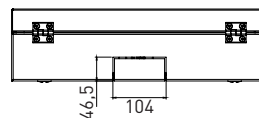
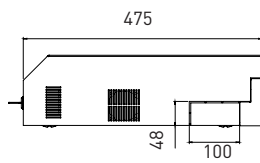
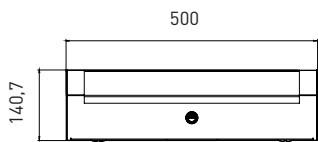
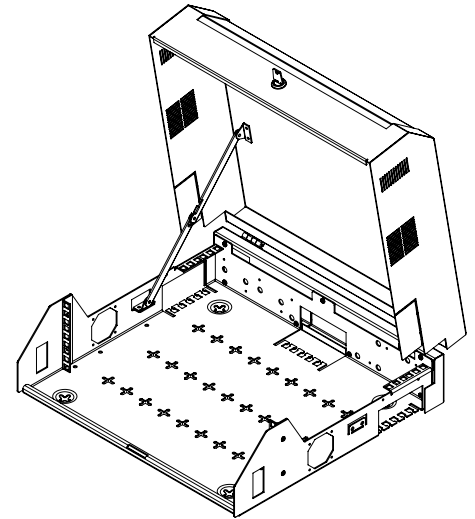
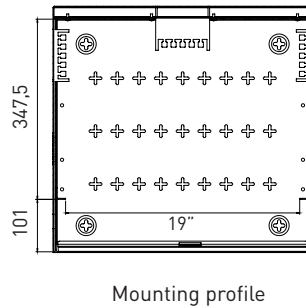
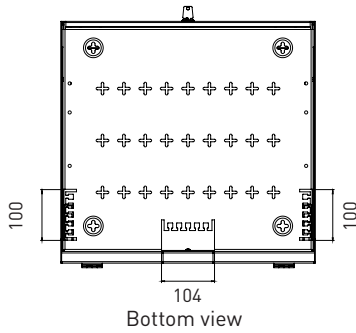

Front view

Side view

Back view

Iso view - open

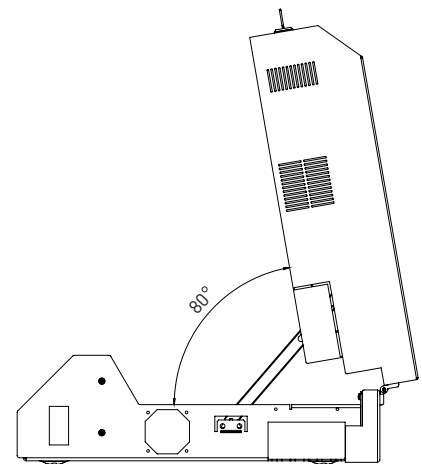
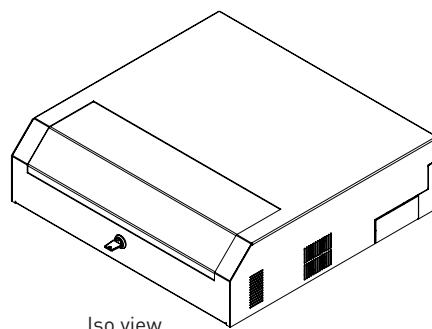
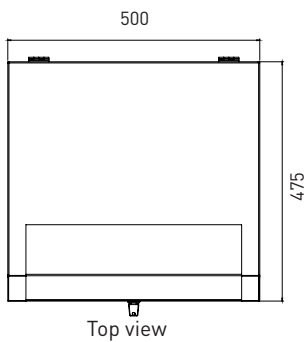

Iso view - open

H= Enclosure height

| PRODUCT REFERENCE | DEFINITION | U SIZE | WIDTH OVERALL (MM) | DEPTH OVERALL (MM) | HEIGHT VERTICAL (MM) |
|-------------------|--------------------------------------|--------|--------------------|--------------------|----------------------|
| SLM007_01M50 | 19" wall mounting cabinets 5U: 3U+2U | 5 | 500 | 475 | 140 |

Note: Color code "M50" is RAL 9005 black, "M2" RAL 7035 light grey option is available.

TESTS AND COMPLIED STANDARDS

TESTS AND COMPLIED STANDARDS

- 1) ISO 9001:2015 Quality Management System
- 2) ISO 14001:2015 Environmental Management System
- 3) ISO 27001:2013 Information Security Management System
- 4) ISO 45001:2018 Occupational Health and Safety Management System
- 5) 19" device mounting uprights IEC 297-1
- 6) EN 61587-1 Mechanical structures for electronic equipment.
- 7) All cabinet sizes complies with IEC 297-2.

**RESISTANCE TO ENVIRONMENTAL CONDITIONS AND CORROSION;
STABILITY, MECHANICAL SAFETY, RESISTANCE TO STATIC, DYNAMIC
AND MECHANICAL LOADS;
RESISTANCE TO VIBRATION, MECHANICAL SHOCK AND IMPACT;
DEGREES OF MECHANICAL PROTECTION PROVIDED BY THE
ENCLOSURE (IP20);
ELECTRICAL GROUNDING CONTINUITY;
FIRE AND FLAME RESISTANCE;**

Have been tested according to the standard " EN 61587-1" with the normative standards: IEC 60917, IEC 60297, IEC 60068-1, IEC 60068-2, IEC 60695-11-10, IEC 60950-1, contained and certified by the notified organizations::

TSE CERTIFICATE NO

003788-TSE-08/02

EAC CERTIFICATE NO

0443637, 0776963, 0345864, 0401678, 0776653

CORROSION

ISO 9227 Standard complied by the test report METALTEK AB-0547-T / 0157-1

TRANSPORT

ETS 300 019-1-2 Class 2.3 Comply with internal testing

STORAGE

ETS 300 019-1-1 Class 1.2 Comply with internal testing

SURFACE FINISH

Electrostatic powder coated c/with surface treatment , 80 +/- 5 micron paint thickness

PURCHASED PRODUCT CERTIFICATION

SHEET STEEL

EN 10346: 20015 DX51D+Z, EN 10130: 2006 DC01

ELECTROSTATIC POWDER COATING

ISO6860, ISO2409, ISO1520, ISO2815, ISO6272, ISO7253, ISO6270-1, ISO2812

ISO 9001, RoHS

GLASS

TS EN 12150-1, TS EN 1863-1

LOCK

IEC 62474, REACH, RoHS

CASTORS

ISO 9001, TS EN 12532, RoHS

FAN

IEC 60335-2-80:2002, IEC 60335-1:2010

